

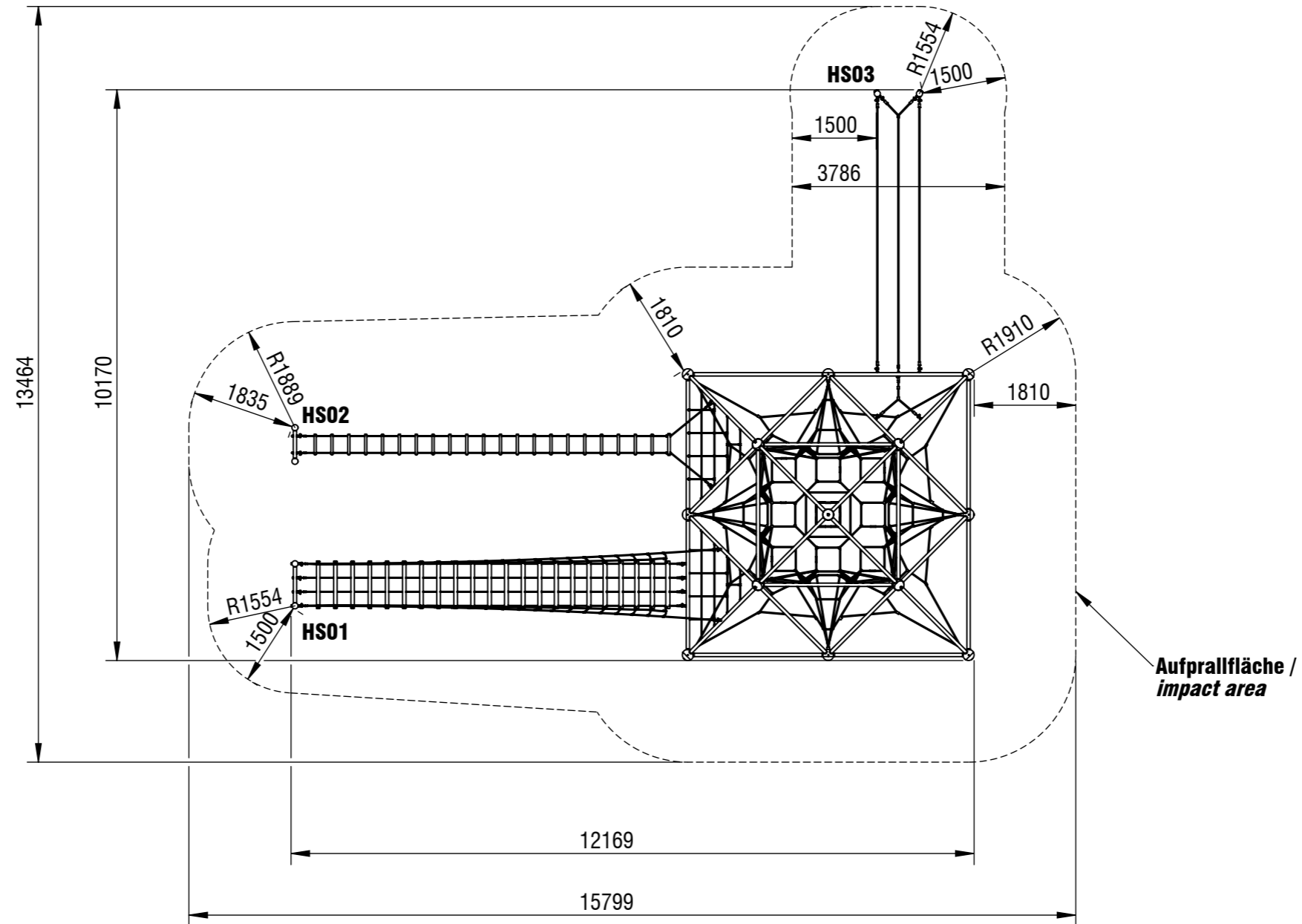

# Planvorlage 1 / draft plan 1



**max. freie Fallhöhe / max. free height of fall:** 2,47 m  
**Aufprallfläche gesamt / total impact area:** 137 m<sup>2</sup>

\*Maßstab gilt nur für smb original Ausdrücke / scale only applies to smb original printouts

Gerätename / equipment name	Mount Logan V1			smb Seilspielgeräte GmbH Berlin in Hoppegarten Technikerstraße 6/8 DE-15366 Hoppegarten
Artikelnummer / article number	3153017			
Maßstab / scale*	1:100	Maßangaben / dimensions	mm	
Format / format	A3	Datum / date	31.03.2026	info@smb.berlin www.smb.berlin 

# Planvorlage 2 / draft plan 2

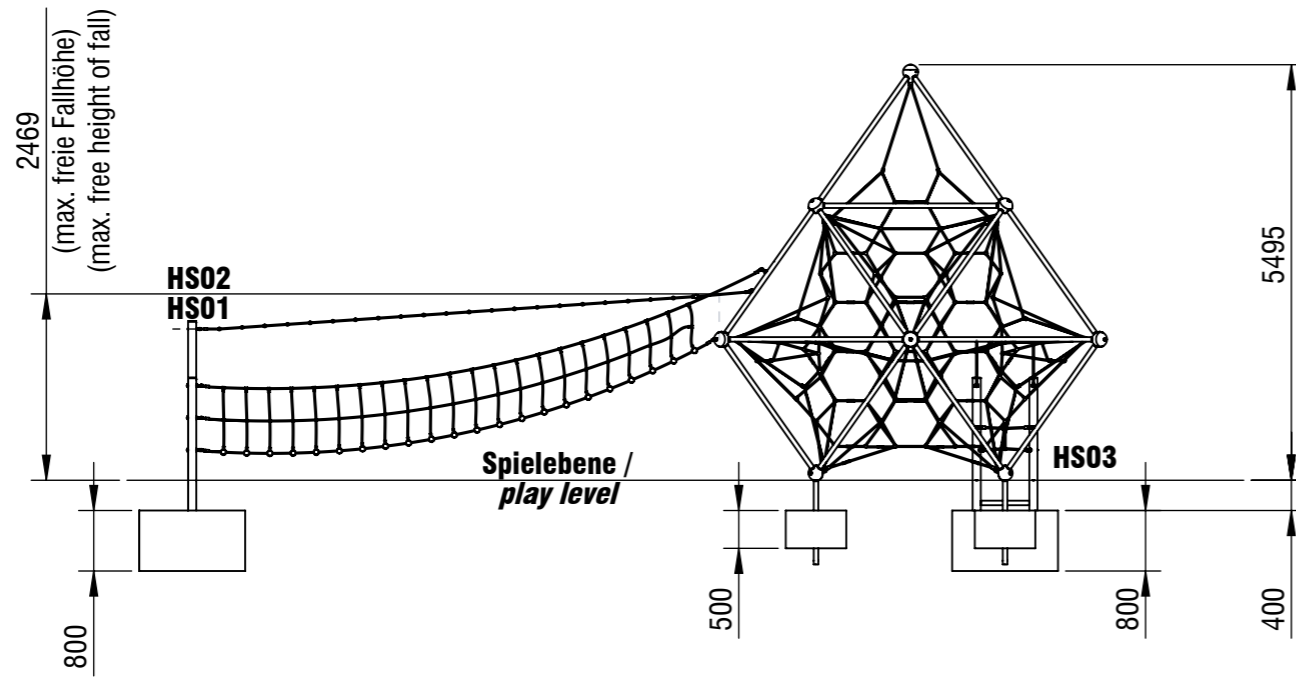

**Fundamentalschnitt / foundation cut**  
**Fundamentanker / foundation anchor**

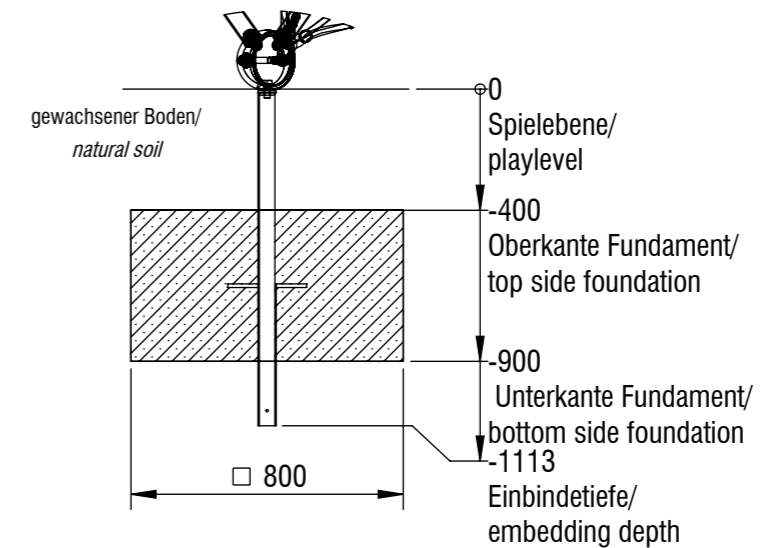

ohne Maßstab / without scale

**Darstellung ohne Netze /**  
**representation without nets**

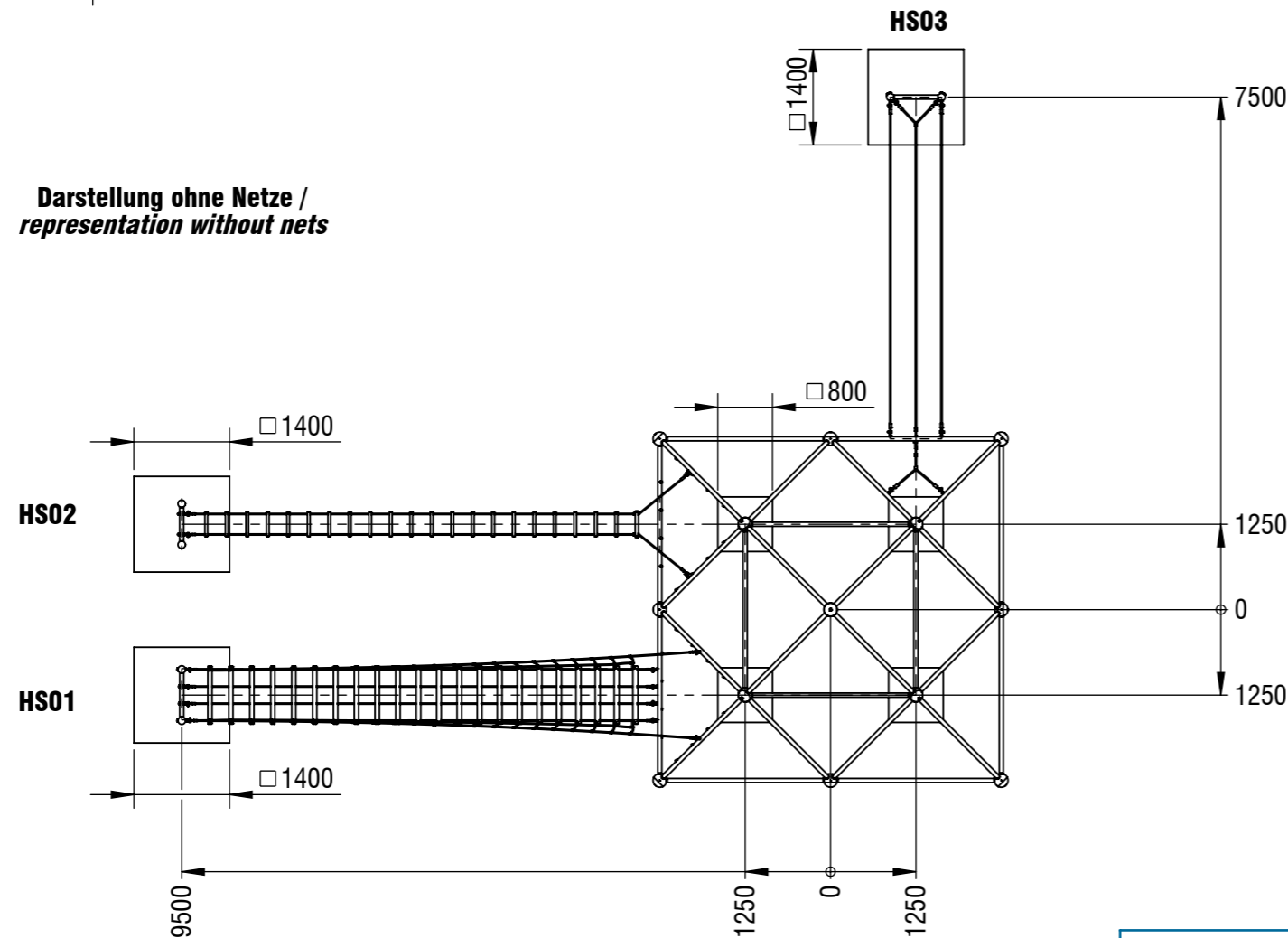

**Fundamentalschnitt H-Stütze /**  
**foundation cut H-post**  
**HS01, HS02, HS03**

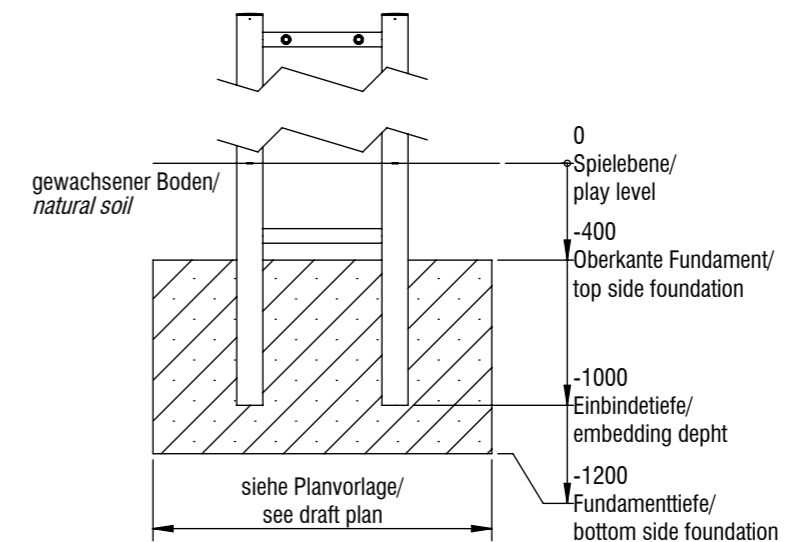

ohne Maßstab / without scale

**Fundament Anzahl/ number of foundations: 7**

**Betonmenge/ Concrete quantity: 5,98 m<sup>3</sup>**

**Mindestbetongüte/ minimum concrete quality: C20/ 25 (B25)**

**Endfestigkeit/ final strength: ca. 28 Tage/ approx. 28 days**

\*Maßstab gilt nur für smb original Ausdrücke / scale only applies to smb original printouts

Gerätename / equipment name	Mount Logan V1			smb Seilspielgeräte GmbH Berlin in Hoppegarten Technikerstraße 6/8 DE-15366 Hoppegarten
Artikelnummer / article number	3153017			
Maßstab / scale*	1:100	Maßangaben / dimensions	mm	info@smb.berlin www.smb.berlin
Format / format	A3	Datum / date	31.03.2026	

# Planvorlage 3 / draft plan 3

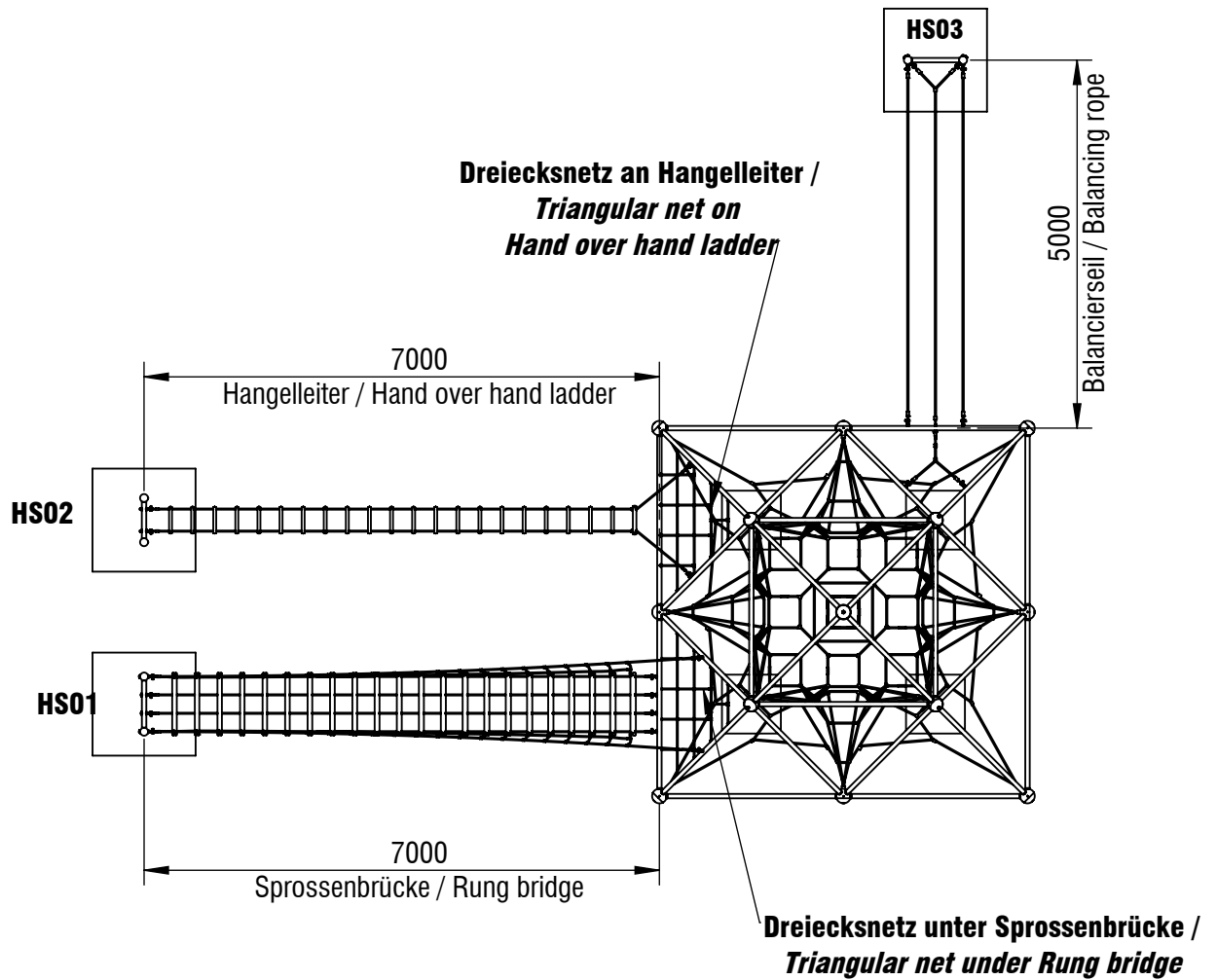

\*Maßstab gilt nur für smb original Ausdrücke / scale only applies to smb original printouts

© smb Seilspielgeräte Manufaktur GmbH Berlin

Gerätename / equipment name	Mount Logan V1			smb Seilspielgeräte GmbH Berlin in Hoppegarten Technikerstraße 6/8 DE-15366 Hoppegarten
Artikelnummer / article number	3153017			
Maßstab / scale*	1:100	Maßangaben / dimensions	mm	info@smb.berlin www.smb.berlin
Format / format	A4	Datum / date	31.03.2026	

